

**Pyrotek®**

# TRANSPORT

ACOUSTIC AND THERMAL SOLUTIONS





Pyrotek is a global engineering leader in providing world-class, acoustic and thermal insulation solutions and specialised system products for the transport industry. Improving the journey between communities means tackling rail infrastructure, public and private bus fleets and also targeting heavy machinery and equipment solutions. With improved high speed metro projects continuing to grow, providing our expertise to effective transport solutions globally is something we are passionate about.





# Index

Global compliance	4
Who we are	5
Transport projects	6
High-performance coatings	7
Thermal and anti-condensation	8
Vibration and isolation control	10
Noise transfer	12
Sound absorbers	14
Engine locomotive	16
Infrastructure and tunnels	18



# GLOBAL COMPLIANCE

Future growth demands compliance with new and varying international codes.

Pyrotek is 100% committed to delivering international testing and results to ensure safety, material quality and excellent performance.

*Our products are independently certified, time tested and supported by proven results.*

With ISO 9001 quality system certification, our global engineering team design highly specialised solutions to every specification and performance requirement.



Road transport applications mean improved comfort to the driver, passengers and reduced road noise. Weight saving, acoustic/thermal transfer, and longevity of structure means improved comfort for passengers.



Design of more popular LRV has requirements for more efficient materials to save weight and space in the design.



Increased fire requirements across rail industry and demand for reduced weight means increased safety, and more comfortable environment for passengers.

WE SUPPORT YOU ACROSS

35<sup>+</sup>  
countries

80<sup>+</sup>  
locations





## WHO WE ARE

- A global manufacturer of insulation materials to the rail industry
- Provider of technical services and solutions
- Our Noise Control division began in Australia in 1988 bringing over 30 years experience
- We supply complete turn-key solutions for many industries with over 300 application engineers

## WHY CHOOSE US

- Strong R&D laboratory team - acoustic, thermal engineers help maximise product performance
- Extensive data analysis and noise predictions
- Design capabilities using CAD and 3D modelling
- Global test laboratories for fire, acoustic and vibration
- Engineering & manufacturing centres worldwide



## TRIED AND TESTED

Highly versatile, simple application solutions with intelligent material properties.





# TRANSPORT PROJECTS

Pyrotek has a long history of serving the transport industry. Decades of experience have seen us adapt and develop high performance materials to suit the needs and regulatory demands of our customers.

Our global network with significant experience covers; light rail, metro, commuter, regional, intercity and high speed trains; electric and diesel locomotives; bus and large vehicle networks including passenger, urban and regional coaches and other transit or people moving applications.

1993	Australia	ABB Transportation	Xplorer	DMU
2002	Australia	EDI Rail	Millennium	Double Decker Metro
2004	Australia	Bombardier	Velocity	DMU
2006	Australia	UGR	Hunter Railcars (J Sets)	DMU
2008	China	Siemens/CNR	Beijing-Tianjin Intercity Railway (CRH3C)	High speed EMU
2010	China	China Railway vehicles	Waratah	Double Decker Metro
2012	Czech Republic	Skoda Transportation	Konia	28T LRV
2013	Czech Republic	Skoda Vagonka	NIM Express	Double Decker EMU
2013	India	Alstom	Chennai Metro	Metro
2013	China	CNR	Rio de Janeiro Suburban	EMU
2016	India	BEML	Metro cars	Metro
2017	China	CRRC	SGT Waratah	Double Decker Metro
2018	Poland	Stadler	Tango-Ostrava	Tango LRV
2018	Indonesia	PT Inka	Bogor-Jakarta LRT	EMU
2021	Australia	Alstom	Perth-Metronet	EMU / DMU
2021	India	Alstom	MML3	Metro



Turkey - SKODA Tram



Czech Rep. - STADLER Tango Tram



China - Siemens CNR, high speed



Australia - Alstom, Metronet



**DELIVERING TRAINS WORLDWIDE SINCE 1970**

For more stories of success, visit [www.pyroteknc.com/case-studies/](http://www.pyroteknc.com/case-studies/)

# HIGH-PERFORMANCE COATINGS

Our coatings have been developed together with our customers to suit typical and special conditions. Lightweight and high performing, our formulations are easy to apply, hard wearing, optimized to suit transport applications. Better coverage, higher performance.



Comparison of coverage (m<sup>2</sup>) for 1 kg wet damping coating applied at 1 mm dry film thickness (DFT)

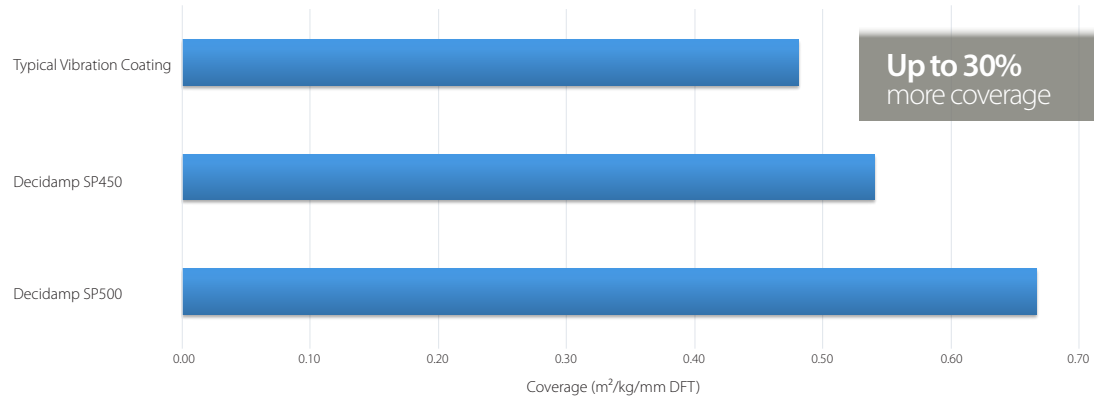

Damping coating loss factor

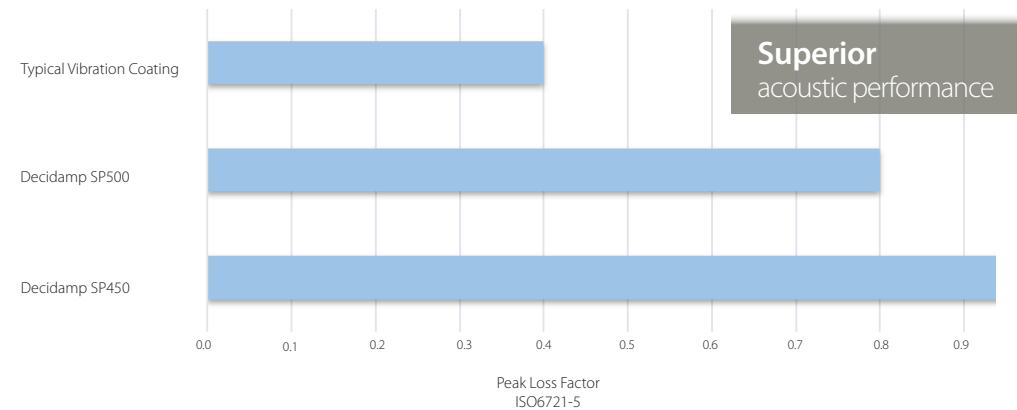

## CUSTOM PARTS AND KITS

For easy installation, all materials are available to be supplied as pre-cut and labeled parts for your designs. Pre-routed, finished flooring cut to your templates means simpler processing for our customers.

*'Peel n Stick' self adhesive backing available for quick and simple installation.*

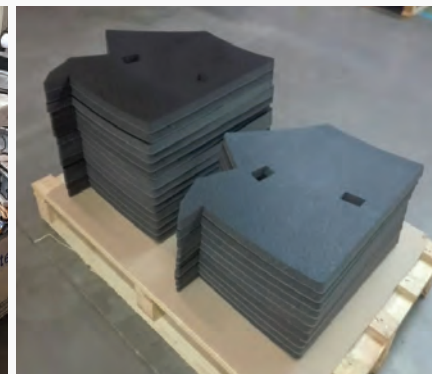

# THERMAL AND ANTI-CONDENSATION

Anti-condensation products inhibit the formation of condensation by introducing a thermal gradient over the entire substrate surface.

*Condensation that results from a large differential in surface temperatures and humidity often leads to corrosion and shortened life of the components and structures. The efficiency of the thermal insulation is also greatly compromised meaning reduced performance of the system over time.*



**Lightweight & highly efficient**  
- Save 400kg per carriage using Decicoat T35

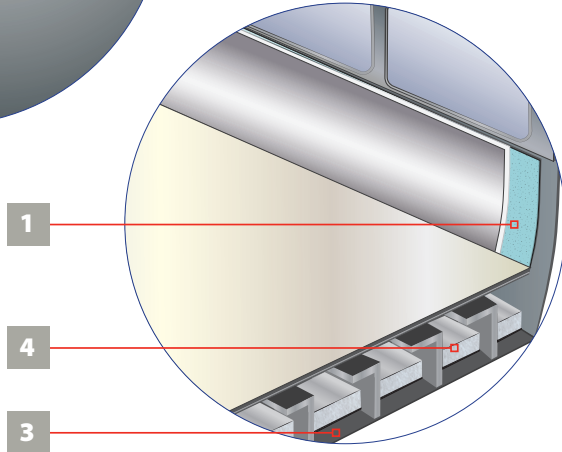
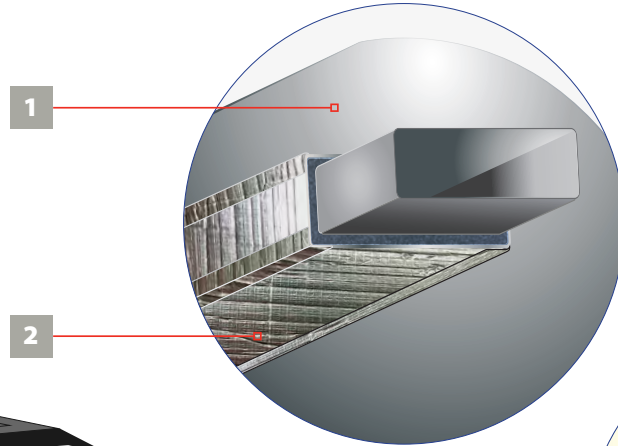
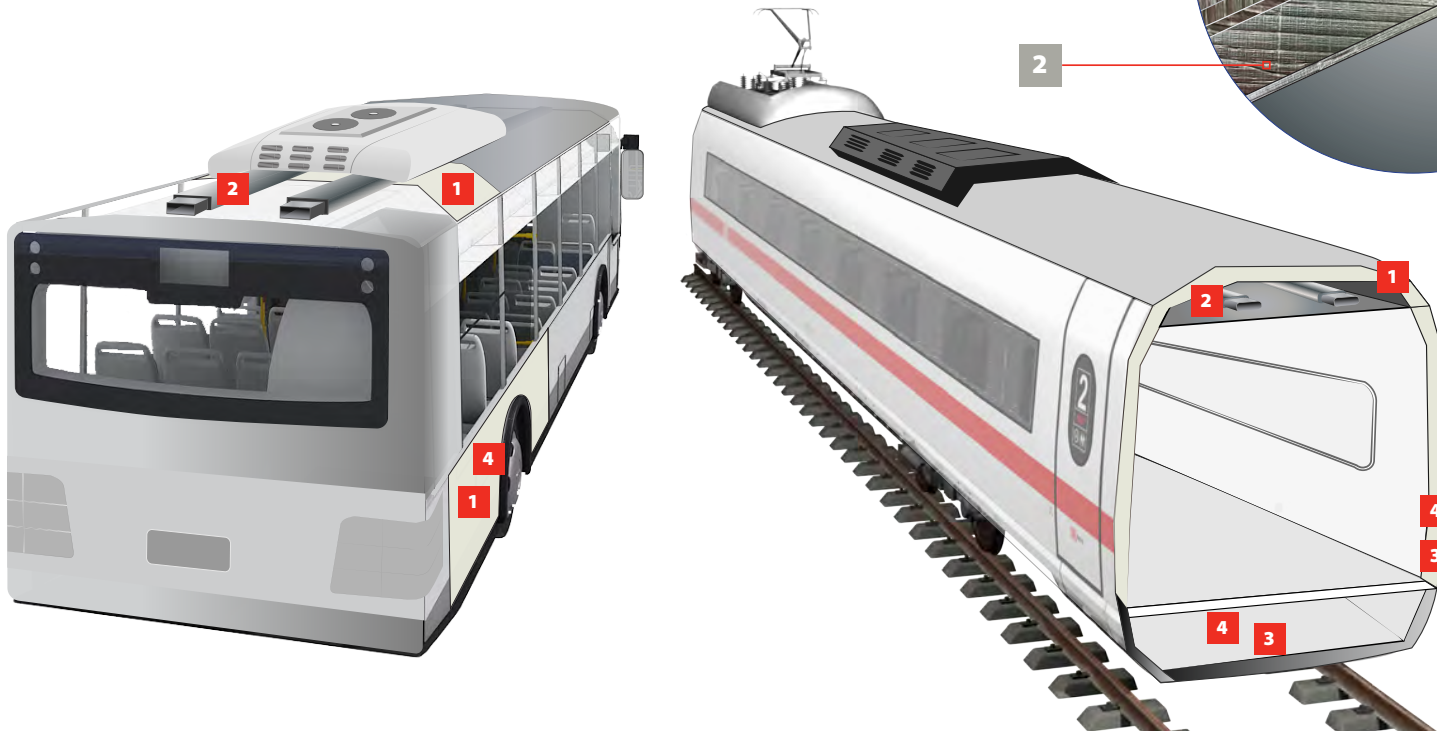

**Quick install**  
extremely thin layer



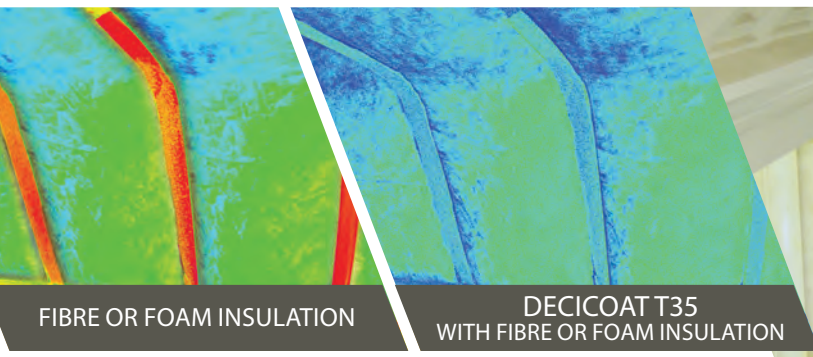

## PREVENTING CORROSION & THERMAL BRIDGING

Surfaces exposed to differential temperatures and high humidity in transport applications require hard wearing, proven thermal solutions to regulate surface temperatures. Corrosion under Insulation (CUI) is difficult to detect and treat in situ, and leads to structure degradation and reduced performance over time.



**DECICOAT T35**

### Lightweight anti-condensation and corrosion protection

Improve the efficiency of thermal insulation without the compromise of thermal bridging. Together with excellent vibration damping properties, it is ideal to use where weight reduction, thermal insulation and acoustic performance are a priority in walls and ceilings in transport applications.

*Complies to Standards: EN45545-2, ASTM E 162/662/800, RISSB AS 7529*



**THERMOBREAK RT**

### High fire rated, lightweight thermal insulation

Excellent anti-condensation flexible closed cell foam with the highest possible fire rating in rail industry. Extremely lightweight, plus easy to cut, handle and install, makes it an ideal material to use around air conditioning ducting where high thermal insulation is required within limited space.

*Complies to Standards: EN45545-2, ASTM E 162/662/1354, RBS 476 6/7, BSS 7239 & BS6853*



**DECICOAT P60**

### Intumescent insulation coating

Prolong the integrity of aluminium or steel structures during fire to allow longer window for evacuation of passengers. Usually 1mm coating is sufficient, will not hinder any thermal insulation material within wall cavities. Once expanded\*, intumescent coating provides effective fire barrier for as long as the substrate integrity is not compromised, hence vital to safe egress in emergency.

*Complies to Standard: EN1363-1*

\*Up to 100 times volume increase for excellent thermal insulation.

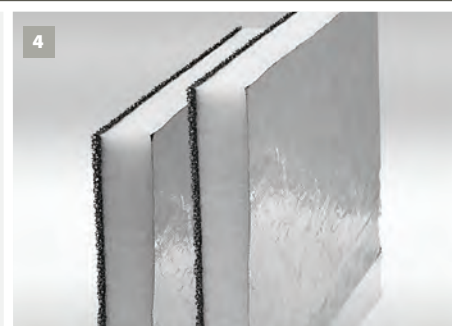

**SORBERPOLY 2D AGC / DR**

### Lightweight acoustic insulation with decoupler for condensation drainage

Ideal combination of high performance lightweight acoustic insulation with an open cell decoupling layer to prevent liquid from accumulating in the absorption material, hence reducing thermal properties of insulation and allowing for corrosion to form. Safer and easier to handle and install than fibreglass and mineral wool alternatives, for use in cavity structures on walls and floors of vehicles.

*Complies to Standard: EN45545-2, ASTM C518 (Sorberpoly 2D), BS 6853:1999 (Sorberpoly 2D)*

# VIBRATION AND ISOLATION CONTROL

Vibration in transportation and particularly in locomotives not only has the issue of adverse noise level but can result in component fatigue-decreased proficiency. Structural soundness of the body over time can be compromised by metal fatigue impacting on longevity of service.

## REDUCE VIBRATION WITHOUT WEIGHT

Consideration for high performance vibration control should not mean extra weight. Lighter, easier to apply compounds mean reduction in structure borne noise, even in limited space applications.

### Protective performance

Excellent vibration damping, high chip resistance

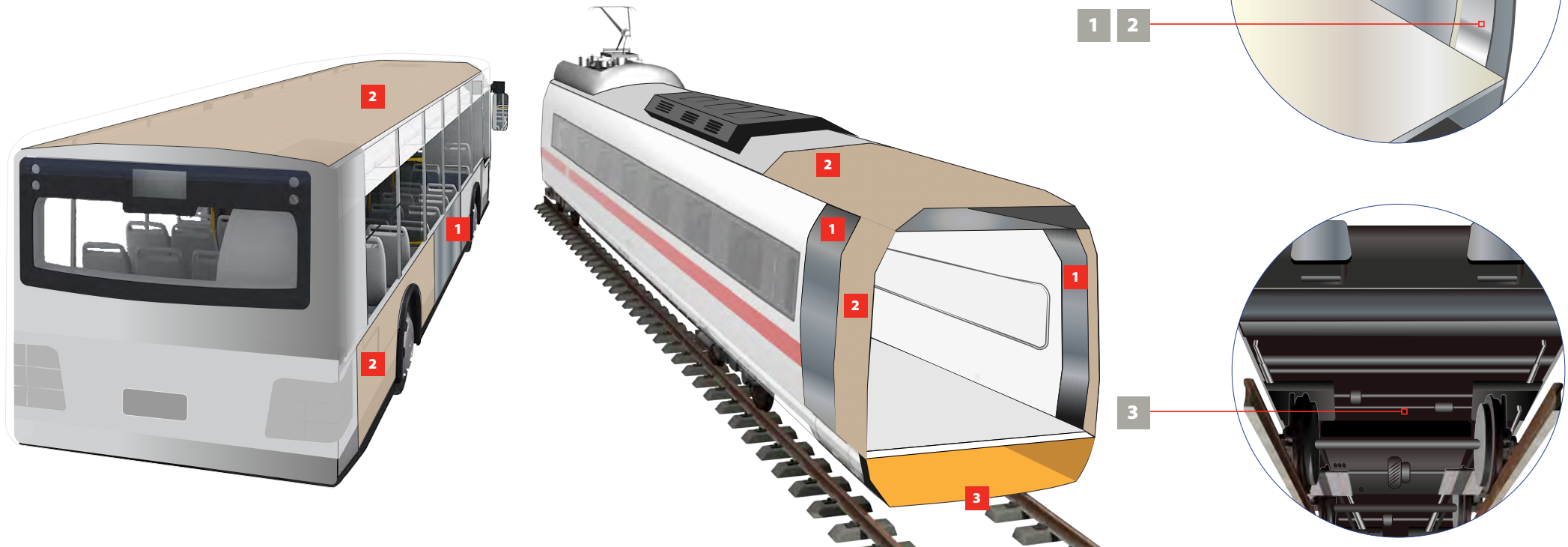





**Highest certification**  
in rail fire standards

**DAMPING AND PASSIVE INSULATION**

Offered in varying surface densities, with different material compositions, grades and specialised features, our materials suit a variety of applications. Specialised compositions are available where specific fire, smoke and toxicity levels are required.

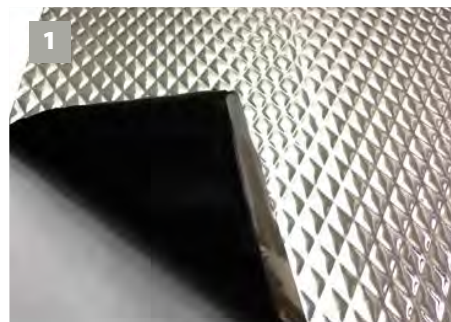

**DECIDAMP CLD PRO**

**Constrained layer vibration damping**

Prevent vibration and sound transmission throughout structures. Considerably shorter application process than with other damping materials as no additional time for drying is required. Provided with 'Peel n Stick' self adhesive backing for quick and easy installation.



**DECIDAMP SP450**

**Lightweight waterbased vibration damping for all surfaces**

For advanced damping and acoustic improvement of structures exposed to vibration. Easily applied on both horizontal and vertical surfaces in interior applications, it exhibits low combustibility and compliance to the latest international fire regulations.

*Complies to Standards: EN45545-2, ASTM E 162/662/800 & BSS 7239*



**DECIDAMP SP500**

**Premium, waterbased protective underbody coating**

Versatile damping and vibration control with excellent adhesion. Developed as a premium underbody vibration solution for rail and tram cars. Waterbased, non-toxic, flame retardant and low VOC, it is a high performance, abrasion and chip resistant, protective underbody coating.

*Complies to Standards: EN45545-2 & GOST 12.1.044-89*

**Smarter coverage**

fast drying, high thickness application in single coat



# NOISE TRANSFER

Noise barriers protect travelling passengers by controlling noise transfer from outside or from engines compartments. Our range of specialised materials are dense, thin, flexible, tear-resistant, durable and effectively reduce the transfer of airborne noise generated from the track and bogies. Improving the journey does not have to result in compromise in safety or operational efficiency.

## UNIQUE COMPOSITES

Developed to simplify acoustic treatment and save space by introducing damping properties to noise barriers. Internally damped materials are the most efficient in terms of noise transfer across full frequency range.

### Floor Systems

Less weight, maximum strength

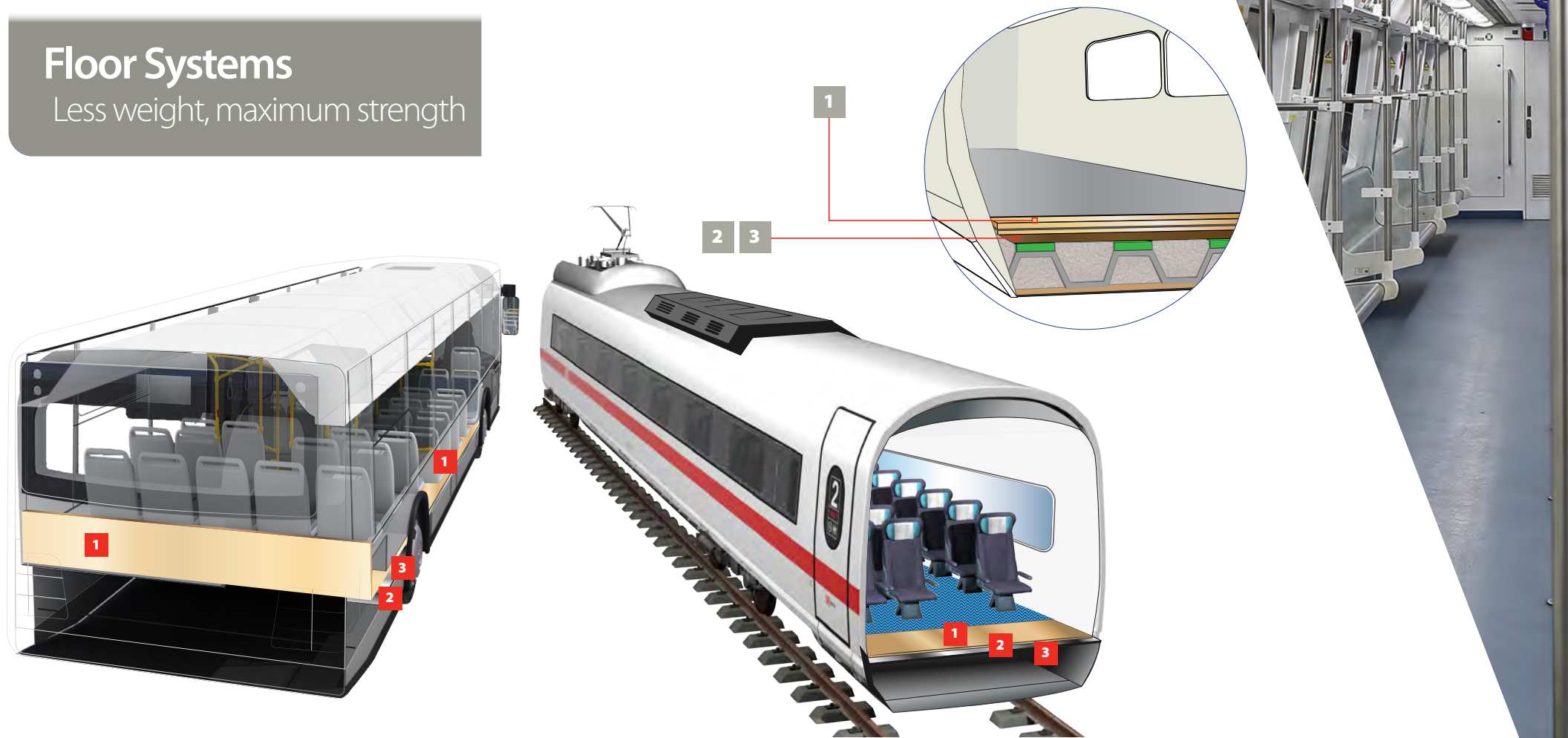

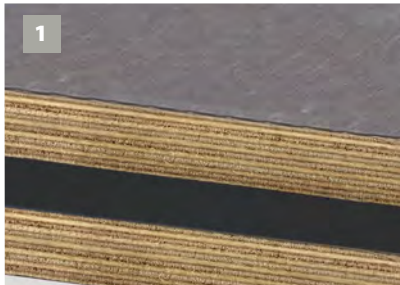
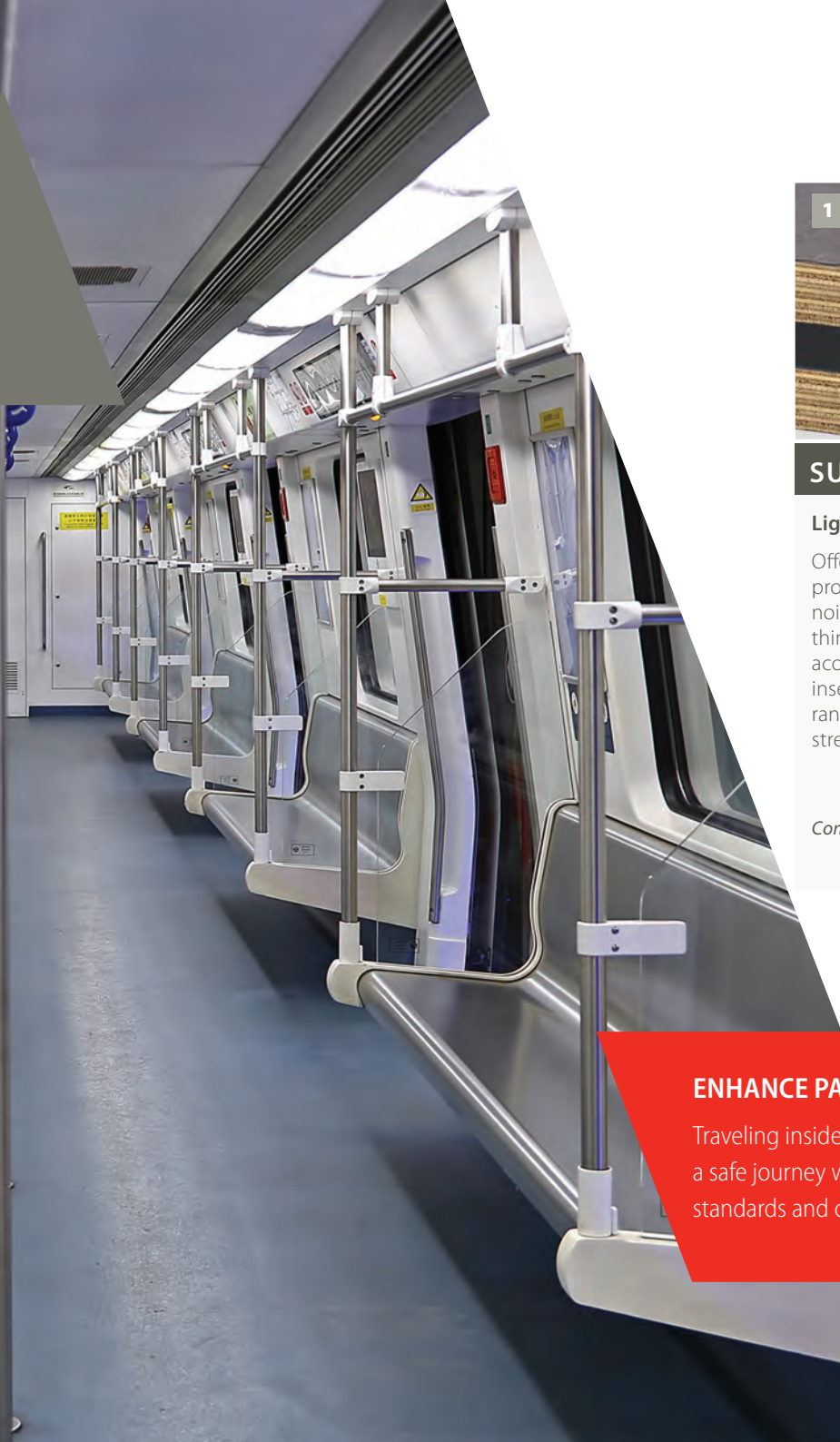

### SUBDUE TR AND TR PLUS

#### Lightweight noise barrier

Offering exceptional acoustic properties by reflecting, absorbing noise. Constructed from a multiple thin veneer layers with or without an acoustic barrier resulting in excellent insertion loss across the full frequency range without compromising strength.

*Complies to Standard: EN45545-2*

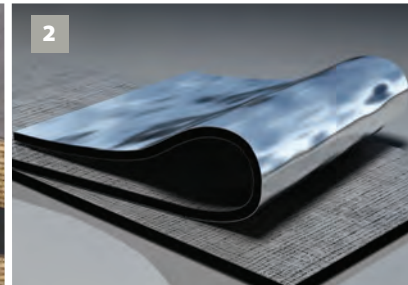

### QUADZERO

#### Ultimate performance noise barrier

High performance, flexible foil-faced, mass-loaded vinyl noise barrier, offering superior acoustic transmission loss and low spread of flame surface covering. Flexible, perfect as addition to current system where space is limited. Globally certified to meet the most stringent requirements.

*Complies to Standards: EN45545-2, BS 476 6/7, TB/T 3138, GB 8624, GB/T 20284, GB/T 8626 & GB/T 2406.*

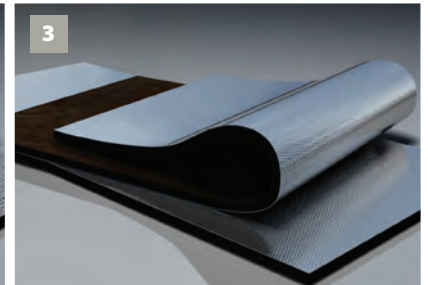

### QUADZERO dBX

#### Thermoplastic, recycled polymer noise barrier for transport

High performance noise control product that exhibits superior transmission loss performance. Perfect as addition to current system and will not impact design where space is limited. Flexible, mass-loaded barrier is laminated with aluminium glass cloth facing.

*Complies to Standards: EN45545-2, ASTM E 162/662/800 & GOST 12.1.044-89*

## ENHANCE PASSENGER COMFORT & SAFETY - A BETTER ENVIRONMENT

Traveling inside a carriage is typically not a quiet experience, however even short trips mean passengers should enjoy a safe journey with adequate protection from mechanical noise generated outside the carriage. Guidelines exist as standards and cover cabin, carriage and tunnel noise exposure as measured at different locations in a train.

# SOUND ABSORBERS

Insulating wall cavities with adequate absorptive material reduces reverberation resulting in lower noise levels inside the carriage. The absorption of reverberation by porous materials is achieved by loss of momentum through the narrow constrictions within porous materials. Our range of specialised materials have optimised acoustic and thermal properties for various applications.

- Address internal cabin noise levels from within walls with considered design and material selection
- Use tested and proven systems for performance and compliance

**Insulate**  
lightweight &  
thermally superior

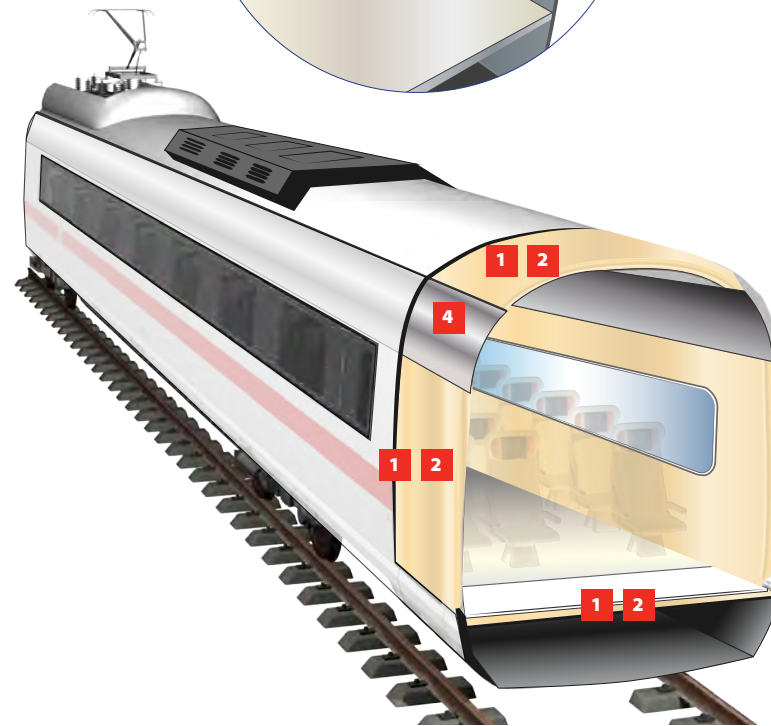
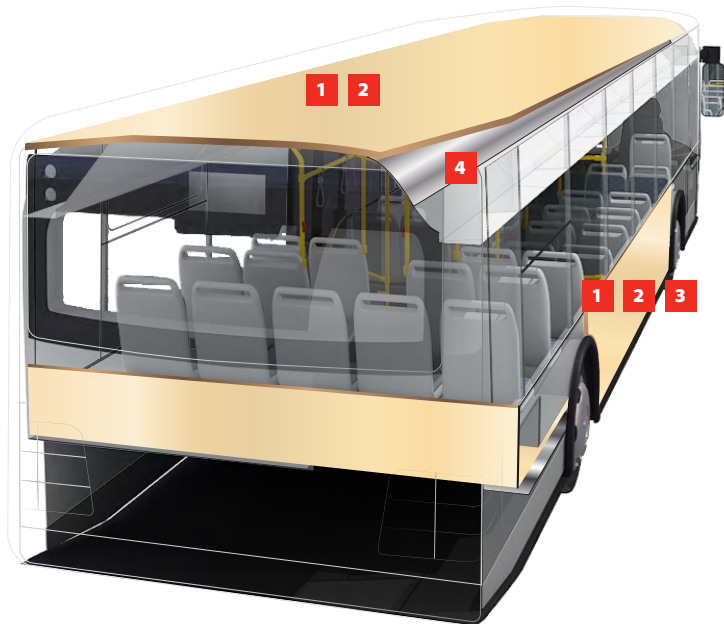
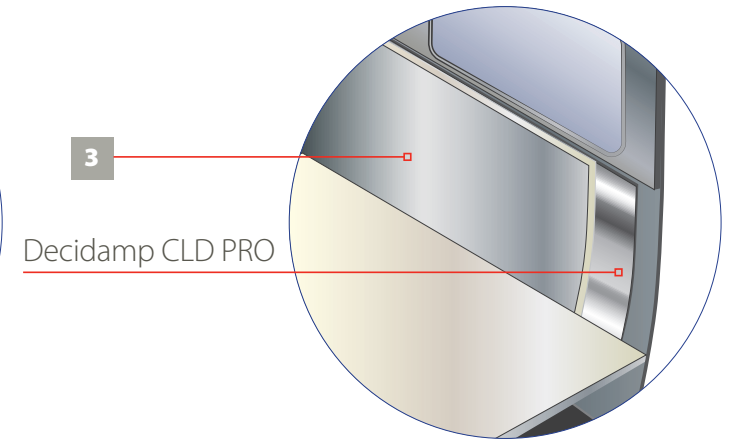
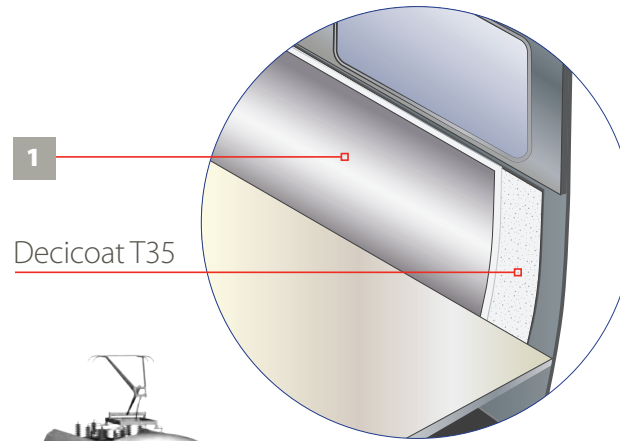



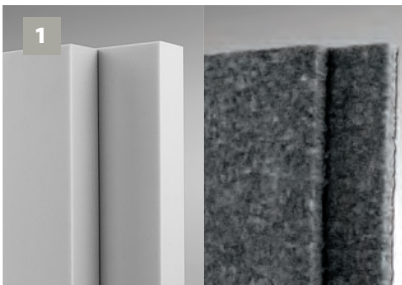

1

### SORBERPOLY

#### Fine fibre, non-woven polyester

Excellent sound absorbing and thermal insulation properties, useful in high humidity applications. Fuel, oil and grease resistant, under normal applications, material will last a life-time. Available in traditional horizontal layer (2D) or vertically lapped (3D) with high resiliency to maintain loft.

*Complies to Standards: EN45545-2 (both), (2D) BS 6853 & NF F 16 101, (3D) DIN 5510, (2D/3D AGC) GOST 12.1.044-89*



2

### SORBERMEL

#### Flexible, light-weight, open-cell, melamine foam

Highly flame retardant, with excellent sound absorption and thermal insulation properties, the material is dimensionally stable and very easy to cut, shape and install.

*Complies to Standard: EN45545-2*



3

### SORBERWOOL

#### Rock wool based

Delivering excellent thermal and acoustic properties. Lightweight and fire resistant on its own and in combination with various facings.



4

### SORBERSCREEN / MICRO

#### Perforated metal sheet sound absorber.

With a robust, durable finish and aesthetic appeal, this unique, micro-perforated 1mm metal sound absorber is formable to various shapes and is non-combustible.



## ABSORB EXCESS NOISE

Reducing the ability for noise to travel through ceiling, wall and floor cavities means a lower internal noise environment within the cabin. Noise absorption is the reduction of reverberated noise within cavities or compartments by use of tailored absorbers most suited to the application.

# ENGINE LOCOMOTIVE

Noise transfer and thermal conductivity in engines and compartments within railway cabins is a significant issue. Heavy gauge steel structures need proven systems and unique compositions to solve tough challenges.

- Unique solutions for locomotive cabins, doors or small enclosure construction
- Improve transmission loss and reduce structure-borne noise

## Perfect driver cabin environment

Combination of vibration damping and barrier materials

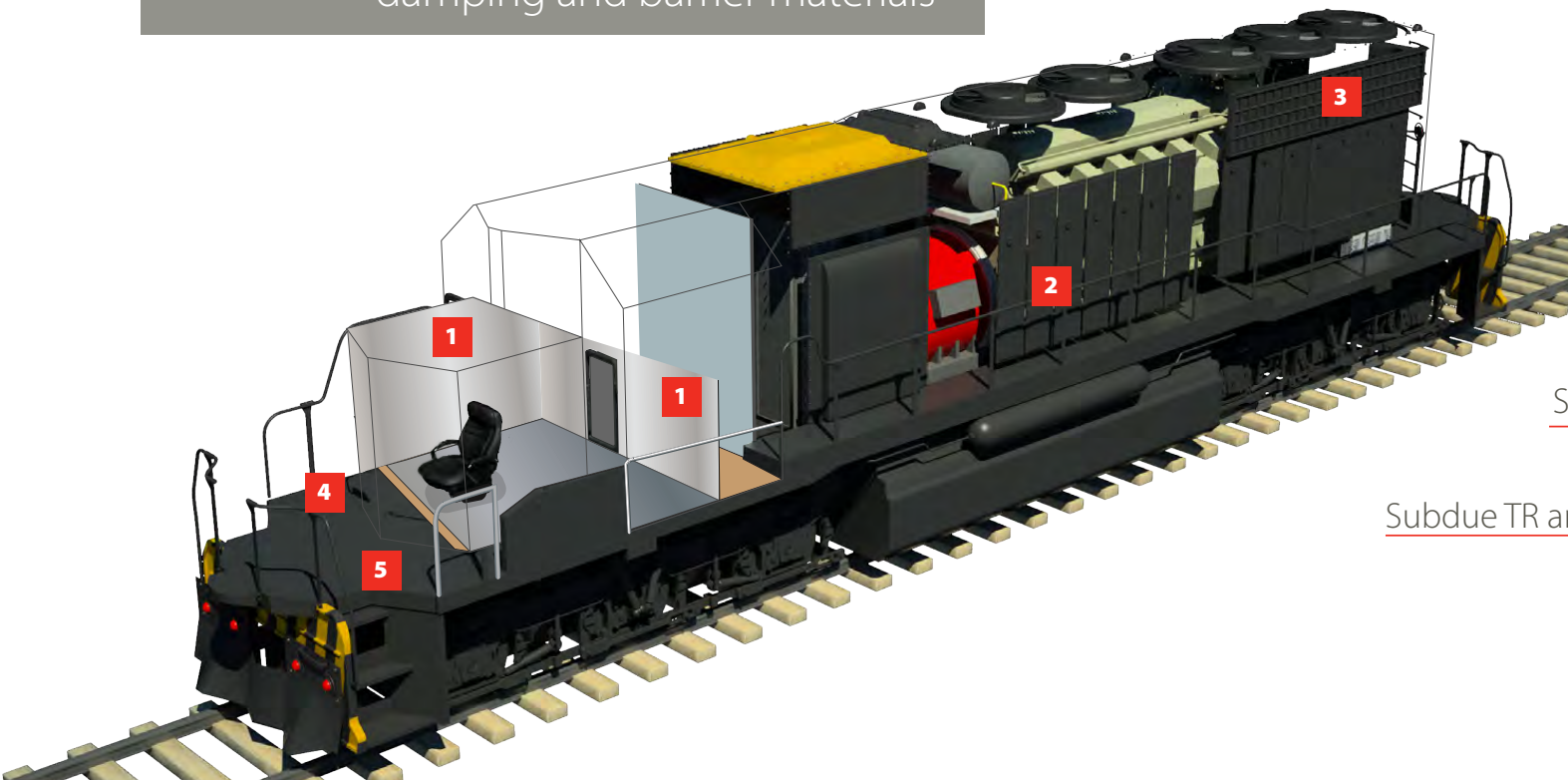

Soundsteel

Subdue TR and TR PLUS







## VIBRATION IN DIESEL AND ELECTRIC LOCOMOTIVES

Vibration in diesel and electric locomotives not only is uncomfortable but can result in structural fatigue. Metal fatigue will impact on longevity of service and structural soundness of the body over time and needs to be addressed from the beginning, ideally in the design phase.



**1**  
**SOUNDSTEEL**

**Tough formable steel composite laminate for damping**  
Internally damped constrained layer material used to manufacture locomotive internal walls and ceiling to minimize structure borne noise within the cabin.

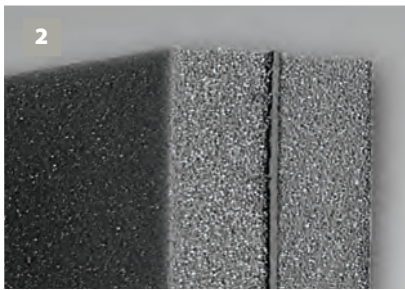

**2**  
**SORBERBARRIER**

**Unique composite multilayer barrier**  
Combines the superior performance of the flexible mass barrier, Wavebar® together with the high absorption properties of Sorberfoam™. Due to flexible Wavebar, and the unique manufacturing process the composite remains flexible resulting in maximum performance over full frequency range.  
*Complies to Standards: EN 4589, DIN5510 & ASTM E 162/662/800.*

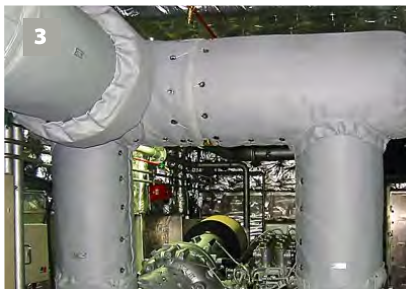

**3**  
**THERMAL COVERS**

**Customised insulated thermal covers for exhausts**  
Pyrotek® design and manufacture fully customised exhaust covers and easily removable thermal jackets that utilise our range of fabrics, felts and blankets to suit a variety of conditions in transport applications.

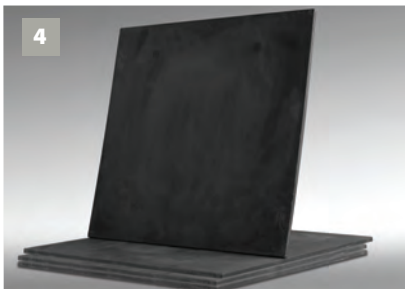

**4**  
**DECIDAMP TILE**

**High performance structural damping tile**  
Engineered to reduce vibrational resonance in thick panel constructions. A new generation polymer suited to use in heavy gauge structures over a broad temperature range. Developed to meet market requirements in rail and heavy vehicle industries.



**5**  
**DECIDAMP DC30**

**Polyurethane counterplate damping medium**  
Excellent two component compound to use in combination with constrained layer system for substantial reduction of structure borne noise. Corrosion resistant, highly thixotropic for use on horizontal and vertical surfaces in transport applications.



# INFRASTRUCTURE AND TUNNELS

Increasing rail speed and frequency of movements means greater noise emissions and impact on residents and the local urban environment. Surrounding infrastructure requires a sophisticated, high performance noise mitigation strategy for nearby walls, tunnels and other areas to protect nearby occupants, commuters and structures. Tunnels are the ideal environment where reverberation can lead to increased noise levels if not suitably addressed with highly durable, absorptive and damping materials.

## REAPOR ACOUSTIC ABSORBER

REAPOR® is constructed with small aerated granules made from recycled glass. The granules are fused together through a patented high temperature sintering process to form a hard, lightweight, fibre-free, non-combustible stone-look panel that can be used indoors and outdoors.

The unique material is highly porous, absorbing noise both between and within the granules.



**NRC 0.95**  
For a 50 mm thick panel

## Sustainable, durable & non-combustible

For challenging, natural-look indoor & outdoor applications



**1**  
**REAPOR**

**High-performance sound absorber recycled glass aerated panels**

Lightweight, strong and rigid, this highly porous, fibre-free, non-combustible solution can be used indoors and outdoors. The stone-look, acoustic panels successfully absorb noise transmission near to tracks, and within tunnels.

*Complies to Standards: EN 13501-1, DIN 4102, AS1530.1 & ISO 5660.*



**2**  
**VITEROLITE 900**

**Non-combustible sound absorber solution for tunnels**

Highly suitable for areas requiring trafficability, higher durability. No VOC or smoke emissions, volatiles, toxic or noxious gases makes it ideal for use in confined spaces such as tunnels and plant rooms. Easily customised, it has been engineered to be laid within and around tracks to absorb broad frequency noise.

*Complies to Standards: AS 1530.1/ISO 1182.*



**3**  
**DECIDAMP RTD**

**Noise reducing extensional rail damper**

High performance polymeric damping pad greatly reduces structure borne noise generated during contact between the track and train wheels in critical frequencies between 630 and 2500Hz. Designed to fit perfectly to the track design, it is also flexible to be adapted to various track dimensions around the world. Quick, easy installation using specially designed brackets ensures a very cost effective damping system.

## SCALED MANUFACTURING

Large infrastructure projects require smart supply with dedicated manufacturing and strict delivery schedules. Local manufacturing around the world means Pyrotek can scale and adapt to suit a project's requirements of supply. Success is only a few steps away. *We can arrange design, production and logistics to every scale.*







## 80+ locations in 35+ countries

- six research and development centres
- five engineering centres
- global headquarters in Spokane, Washington, USA

[pyroteknc.com](http://pyroteknc.com)

### CONTACT DETAILS

For further information or to see your local office please visit our website.



Pyrotek endorse forest sustainability and the preservation of natural environment. We procure the highest quality materials from suppliers who hold FSC (Forest Stewardship Council) Certification and PEFC (Programme for the Endorsement of Forestry Certification) amongst other certification programmes.

Caveats: Specifications are subject to change without notice. The data in this document are typical of average values based on tests by independent laboratories or by the manufacturer and are indicative only. Materials must be tested under intended service conditions to determine their suitability for purpose. The conclusions drawn from acoustic test results are as interpreted by qualified independent testing authorities. Nothing here releases the purchaser/user from responsibility to determine the suitability of the product for their project needs. Always seek the opinion of your acoustic, mechanical and fire engineer on data presented by the manufacturer. Due to the wide variety of individual projects, Pyrotek Acoustic and Thermal is not responsible for differing outcomes from using their products. Pyrotek disclaims any liability for damages or consequential loss as a result of reliance solely on the information presented. No warranty is made that the use of this information or of the products, processes or equipment to which this brochure refers will not infringe any third party's patents or rights. DISCLAIMER: This document is covered by Pyrotek standard Disclaimer, Warranty and © Copyright clauses. See [www.pyroteknc.com/disclaimer](http://www.pyroteknc.com/disclaimer).